

MB833M2K-B MB833MK-B V2

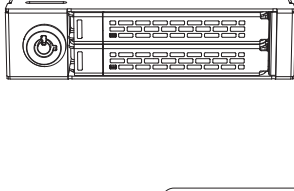

MB834M2K-B MB834MK-B V2



Scan the QR code for more product information

Copyright © ICY DOCK International. All Rights Reserved. 6502933 VER 4.0



Cremax Europe GmbH
Email: support@icydock.com
Weidenweg 21H, 47059 Duisburg, Germany



Beyond Technologies UK Ltd
Email: info@beyondtech.co.uk
Unit B6, Halesfield 11, Telford, Shropshire, TF7 4PH, U.K.

1

Package Contents • Packungsinhalt • Contenu • Contenido del paquete

• 包装について • 包装説明 • 包装说明



Device

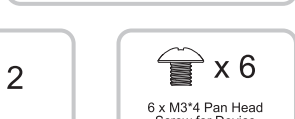

Thermal Pads

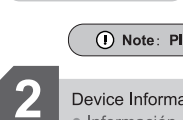

User Manual

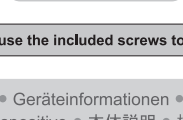

2 x Key



6 x M3*4 Pan Head Screw for Device (2 x Screw for Spare Parts)

Note: Please use the included screws to secure the device

2

Device Information • Geräteinformationen • Informations dispositif

• Información del dispositivo • 本体説明 • 機體説明 • 机体说明

Front View

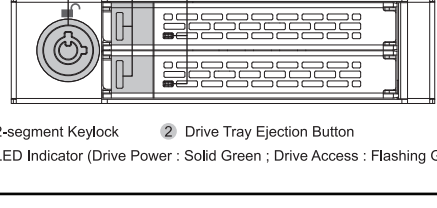

- 1 2-segment Keylock
- 2 Drive Tray Ejection Button
- 3 LED Indicator (Drive Power : Solid Green ; Drive Access : Flashing Green)

Rear View

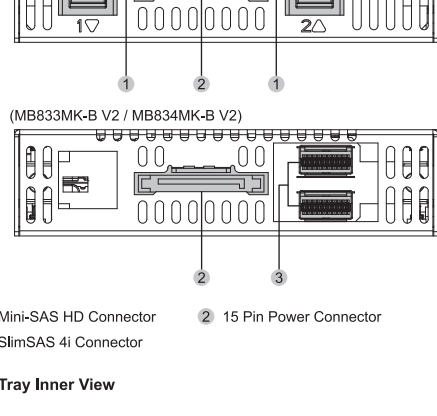

- 1 Mini-SAS HD Connector
- 2 15 Pin Power Connector
- 3 SlimSAS 4i Connector

Tray Inner View

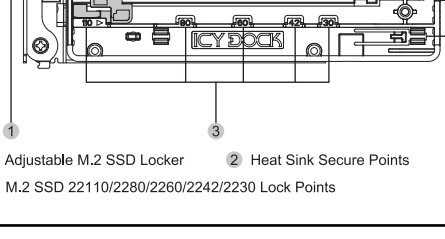

- 1 Adjustable M.2 SSD Locker
- 2 Heat Sink Secure Points
- 3 M.2 SSD 22110/2280/2260/2242/2230 Lock Points

3

Installation Guide • Installationsanleitung • Guide d'Installation • Guía de instalación

• 製品の組み込み手順について • 操作步驟 • 操作步驟

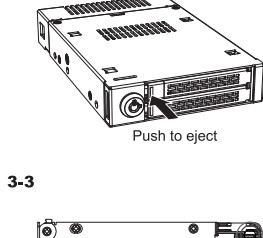

Push to eject

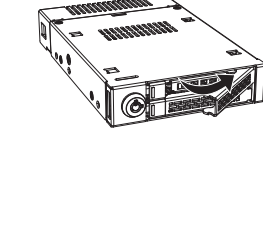

Push Upward

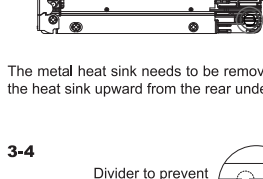

The metal sink needs to be removed before the M.2 tray installation. To remove, simply push the heat sink upward to the rear underside of the drive tray

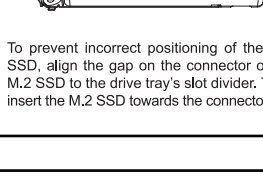

Divider to prevent incorrect insertion

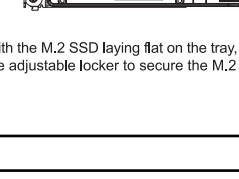

With the M.2 SSD laying flat on the tray, slide the adjustable locker to secure the M.2 SSD

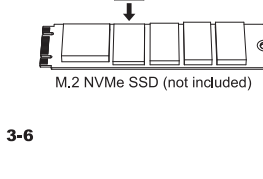

M.2 NVMe SSD (not included)

(Optional) Remove the clear protective films from the small piece of thermal pads and place them on lower flash memory chip(s) to fill the surface gap between the chips and the larger thermal pad for best conductive heat transfer. Skip this step if the memory chips are at the same heights

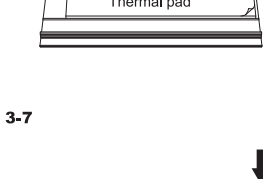

Thermal pad

Remove the protective films from the larger thermal pad and then place it onto the heat sink cover



Place the removed heat sink cover back on

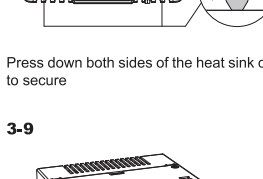

Press down both sides of the heat sink cover to secure

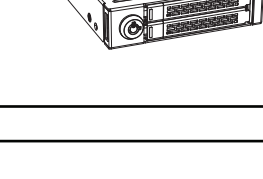
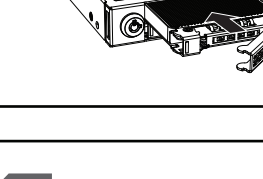

4

Device Installation • Installation eines Gerätes • Installation du dispositif

• Instalación del dispositivo • デバイス取付手順 • 装置安裝步驟 • 设备安裝步驟

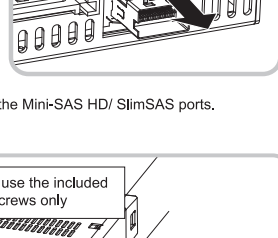
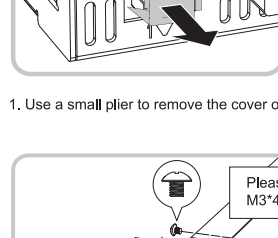

1. Use a small plier to remove the cover on the Mini-SAS HD/ SlimSAS ports.

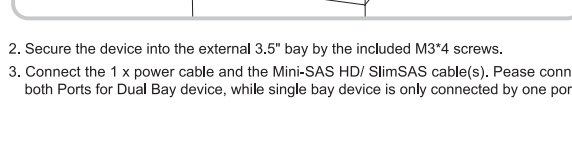

2. Secure the device into the external 3.5" bay by the included M3*4 screws.

3. Connect the 1 x power cable and the Mini-SAS HD/ SlimSAS cable(s). Please connect both Ports for Dual Bay device, while single bay device is only connected by one port.

